

M832・M852

M832 Series

安全縫いミシン

Safety stitch machines

M852 Series

オーバーロックミシン

Overedgers

Parts Checker



PEGASUS®

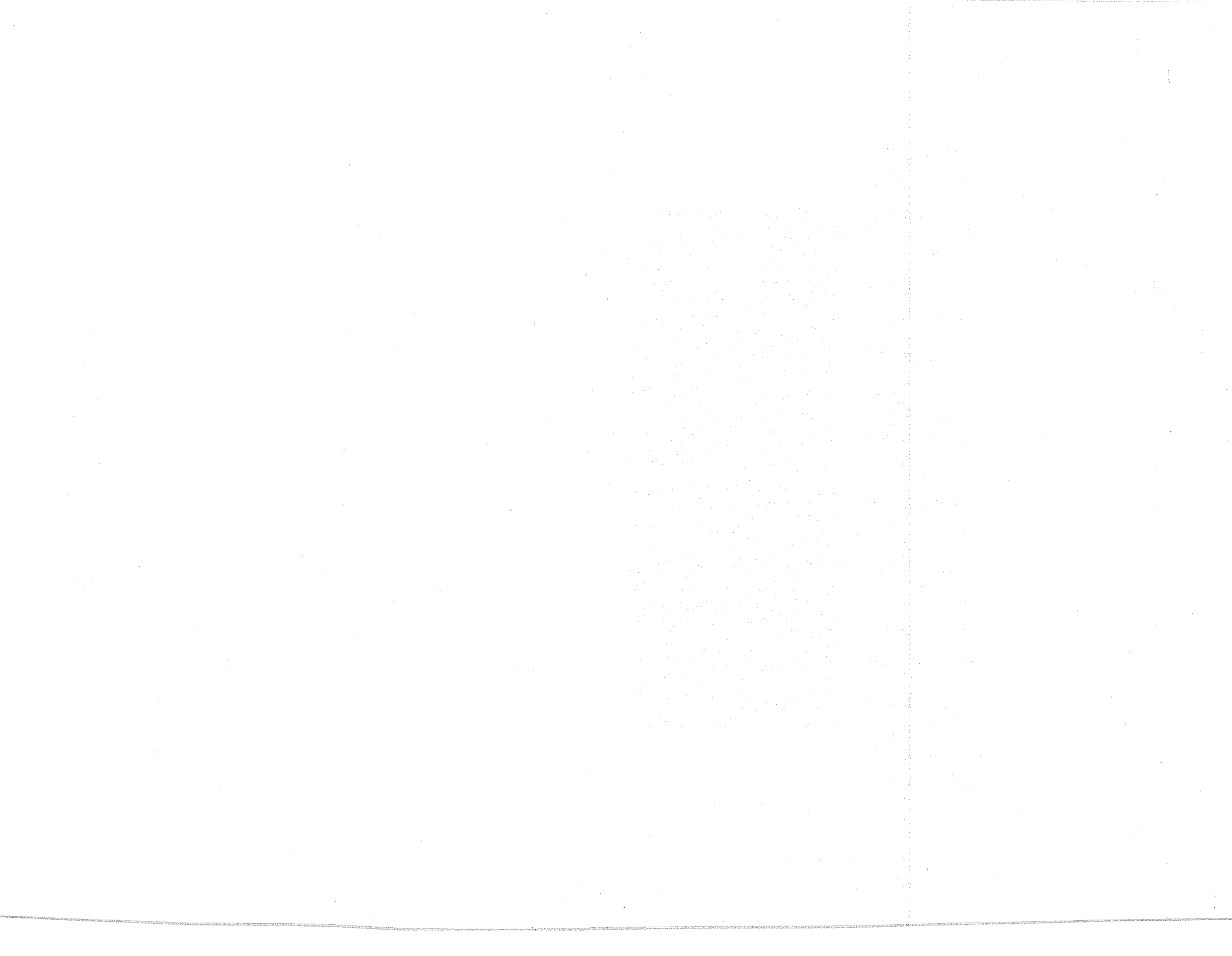

●M832

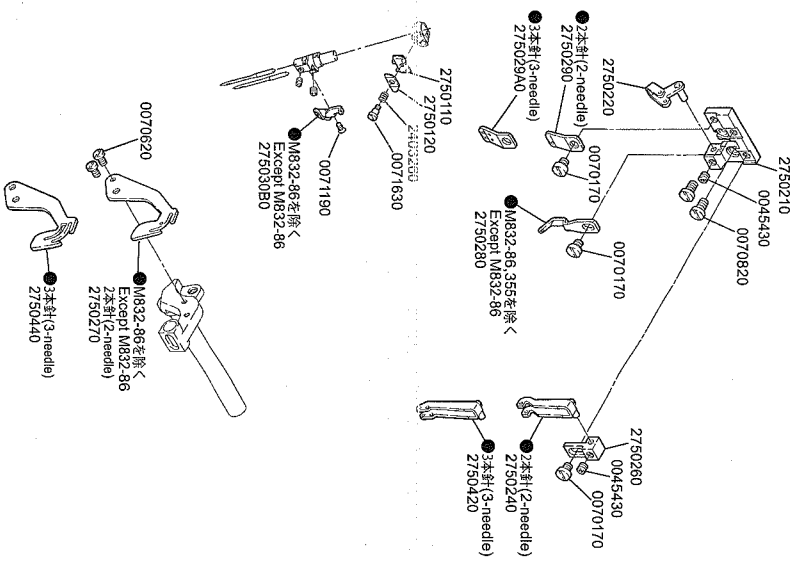

●M852

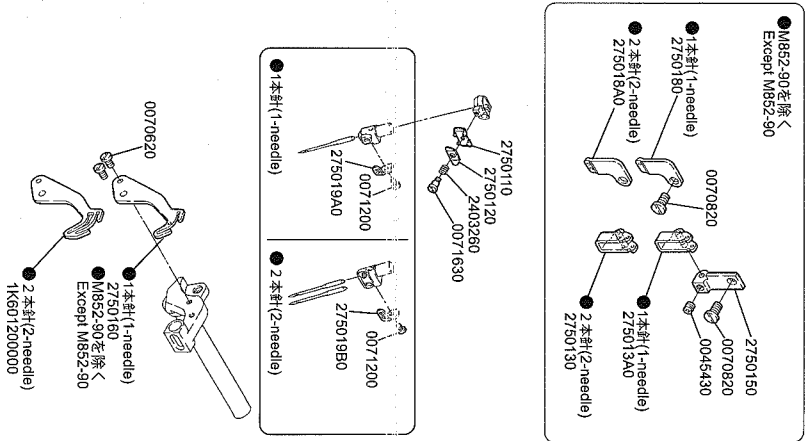

●M832

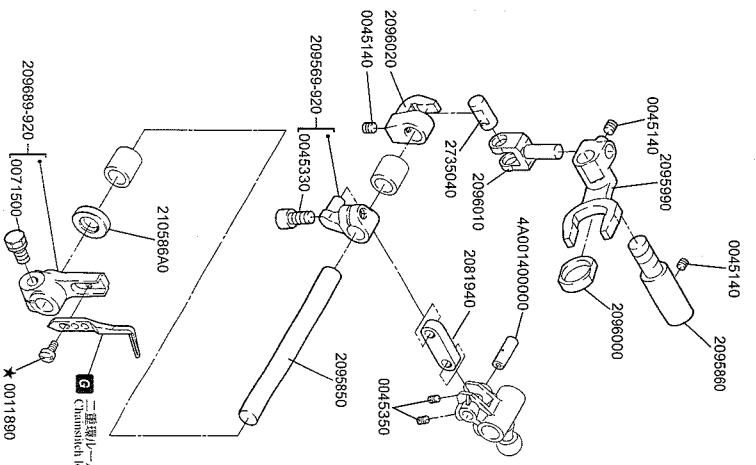

★印はインチサイズです。
 *inch size
 ●G ガーシム(少量参照)
 Refer to the gauge parts list.

●M852-90を除去
 Except M852-90

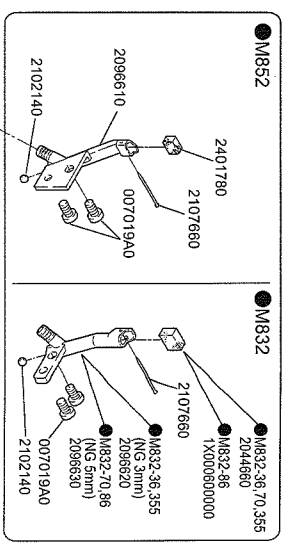
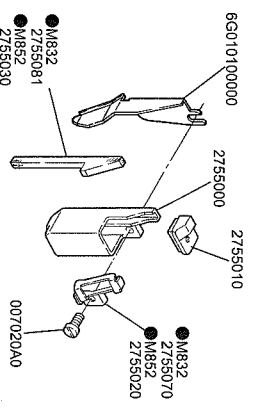

21

- 本立(3-spool) ● 4本立(4-spool) ● 5本立(5-spool) ● 6本立(6-spool)
- 9E001209-P00 9E001269-P00 9E001259-P00 9E001209-P00
- *印は非標準品です。 *Not for sale.

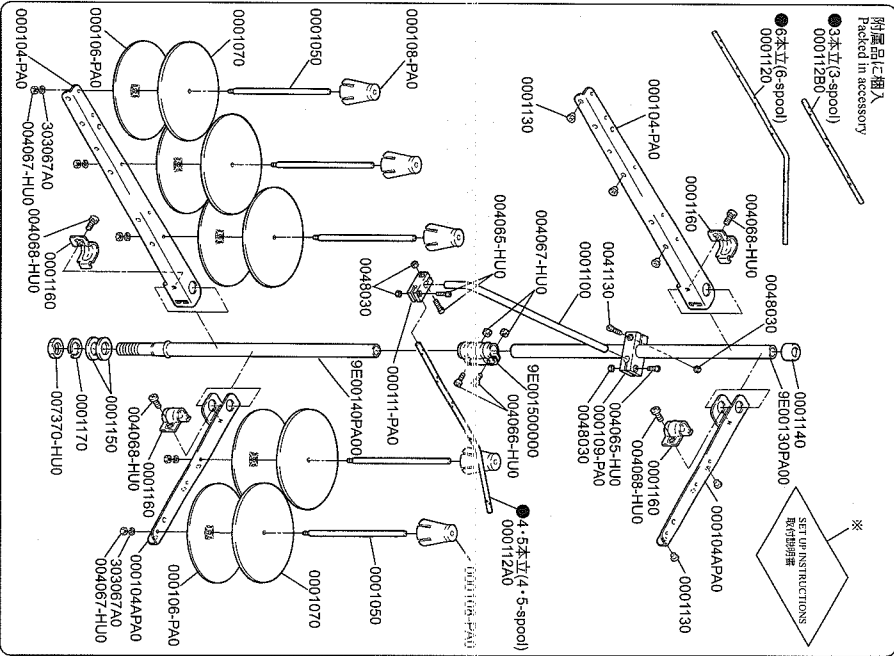

22

- *印は非標準品です。 *Not for sale.

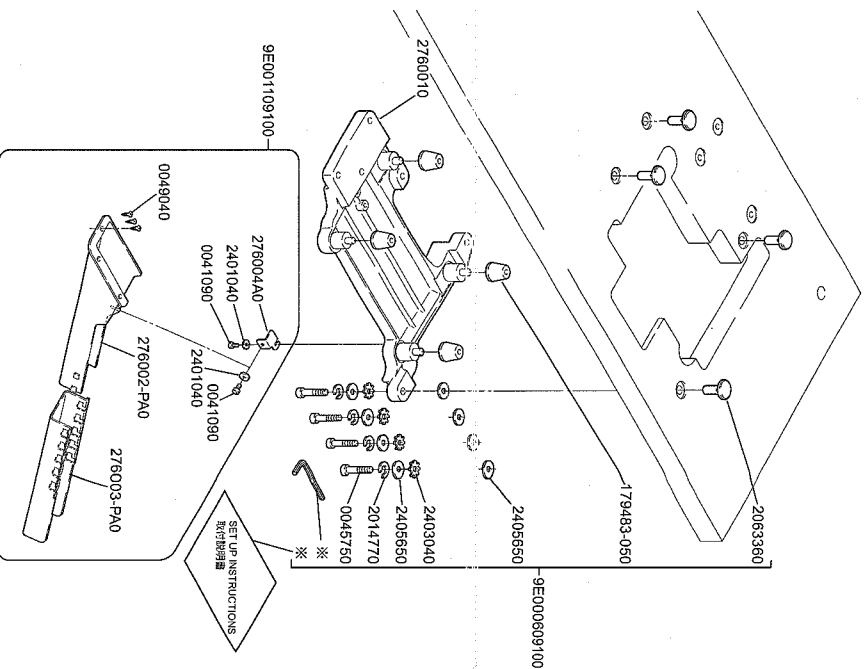

23

- M832-38,70,355
- *印はインチネジです。 *Refer to the gauge parts list.

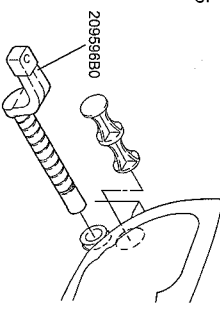

● M832-48,48P2

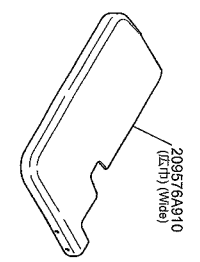

● M832-48

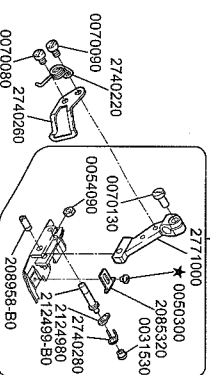

● M832-48P2

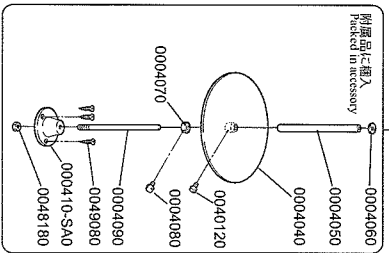
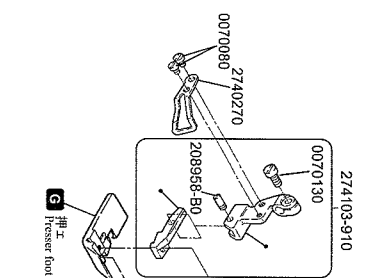

24

- M832-48,48P2
- *印はインチネジです。 *Inch size

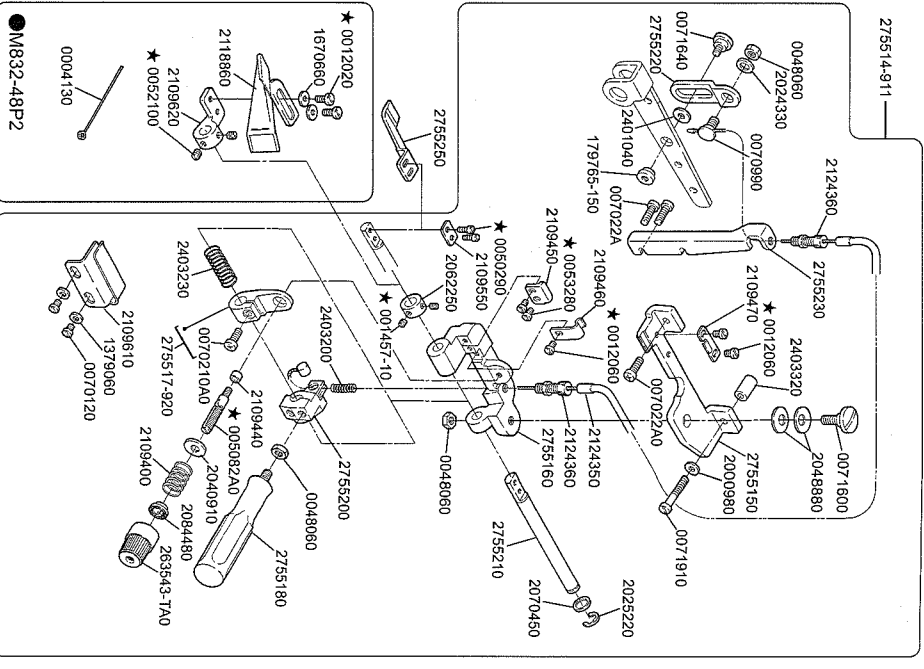

●M832-86

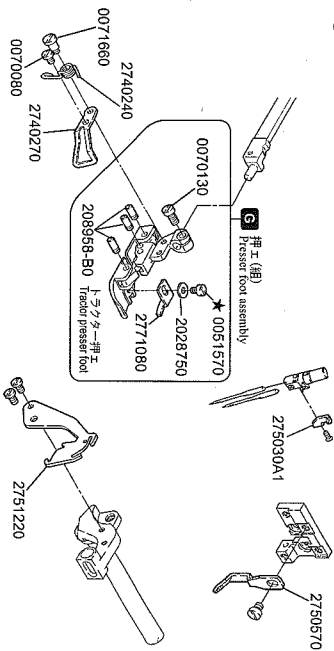

★印はインチサイズです。
★inch size

●M852-01

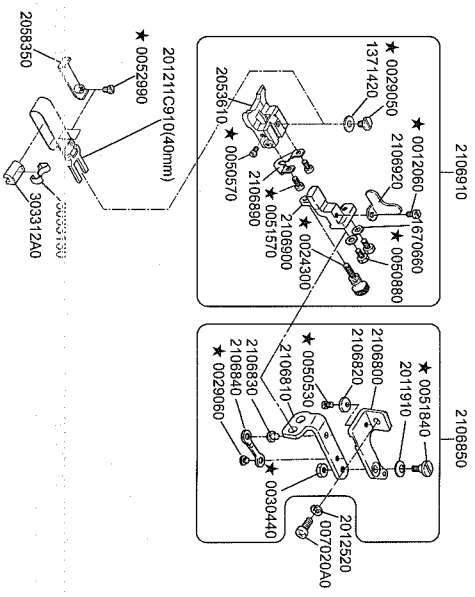

★印はインチサイズです。
★inch size

●M832-86,355

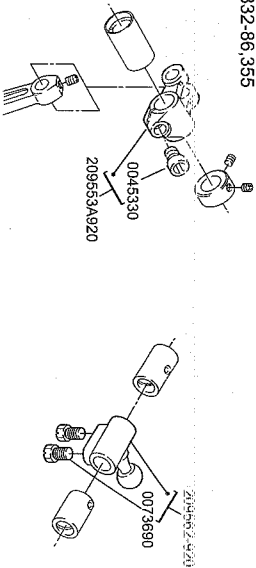

●M832-355

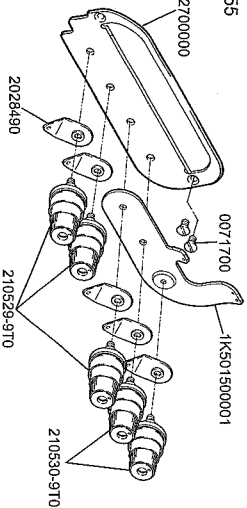

●M852-13

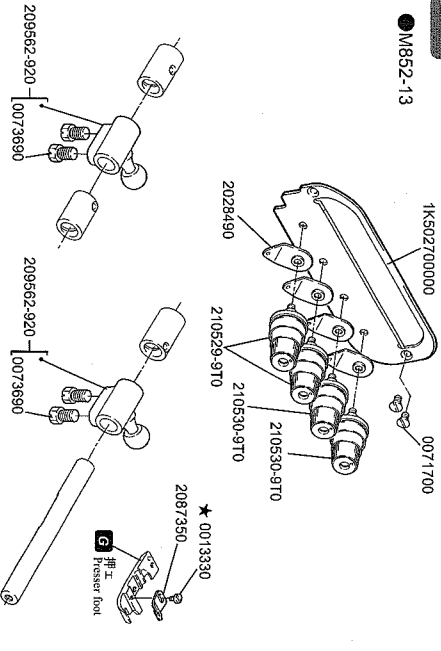

★印は非売品です。
★Not for sale
★印はインチサイズです。
★inch size

●M852-16S2,17,23B

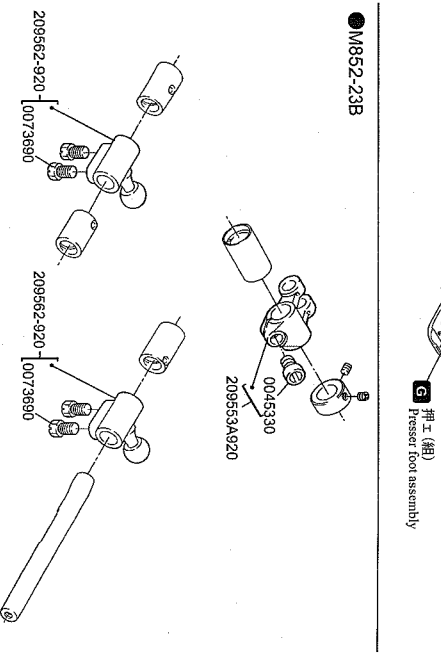

★印はインチサイズです。
★inch size
G ケーシング/ケース参照
Refer to the gauge parts list

●M852-23B

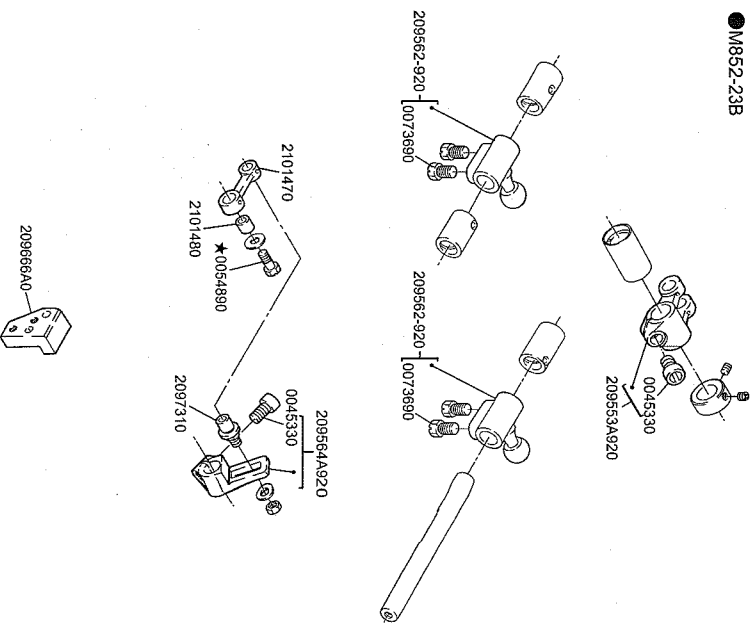

付属品に梱入
Packed in accessory

SET UP INSTRUCTIONS
取組書

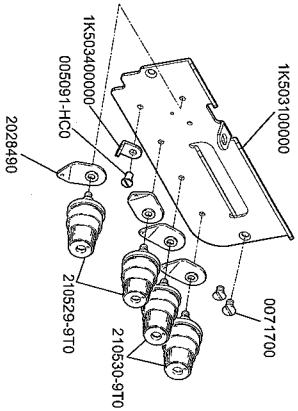
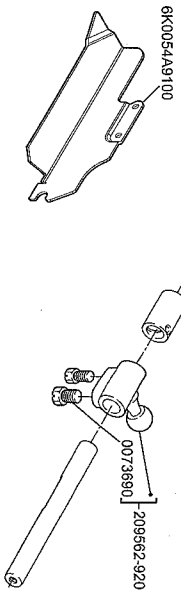
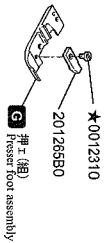

M832 ガージパーツ表

マシン形式 MACHINE TYPE /SPEC.	ゲージ GAUGE	針板 NEEDLE PLATE	主送り歯(組)		主送り歯本体		補助送り歯		差動送り歯		押工(組)		上ルーバー		下ルーバー		二重ルーバー		上メス UPPER KNIFE
			MAIN FEED DOG ASSY.	MAIN FEED DOG	AUX. FEED DOG	DIFF. FEED DOG	PRESSER FOOT ASSY.	UPPER LOOPER	LOWER LOOPER	CHAINSTITCH LOOPER									
M832-38	3	4	204671	2080860	(2043360)	(2080860)	(2080610)	2082180	2771180	2047020 #4	2040720	2098850	201121A0						
M832-48	3	4	2049401	2080740	(2049310)	(2080610)	2044201	2771200	2047020 #4	2040720	2098850	201121A0							
M832-48P2	3	4	2049401	2080740	(2049310)	(2080610)	2044201	20460241	2047020 #4	2040720	2098850	201121A0							
M832-70	5	5	204380A1	2080630	(2043850)	(2080590)	2082150	2771190	2047020 #4	2040720	2098850	201121A0							
M832-86	5	6	2045291	2080640	(2043940)	(2080590)	2082170	2771220	2047030 #9	2040720	209885A0	201121A0							
M832-355	3×2	4	2080481	2080860	(2043960)	(2080600)	2082190	277118A0	2097331 #14	2040720	2098850	201121A0							

M832 GAUGE PARTS LIST

マシン形式 MACHINE TYPE /SPEC.	ゲージ GAUGE	下メス LOWER KNIFE	オーバー針受け		二重溝針受け		針留		針
			前	後	前	後	前	後	
M832-38	3	4	2041610	2096680	2080090	2045360	2096690	277027-921	DC×27 #14
M832-48	3	4	2041610	2096680	2080090	2045360	2096690	277027-921	DC×27 #14
M832-48P2	3	4	2041610	2096680	2080090	2045360	2096690	277027-921	DC×27 #14
M832-70	5	5	2041610	2096680	2080090	2040420	209669A0	277029-920	DC×27 #14
M832-86	5	6	2041610	2096680	2080090	2040420	209669A0	277029-920	DC×27 #21
M832-355	3×2	4	2041610	2096680	2080090	2045360	2096690	2K000309200	DC×27 #11

M852 ガージパーツ表

マシン形式 MACHINE TYPE /SPEC.	ゲージ GAUGE	針板 NEEDLE PLATE	主送り歯(組)		主送り歯本体		補助送り歯		差動送り歯		押工(組)		上ルーバー		下ルーバー		上メス UPPER KNIFE	
			MAIN FEED DOG ASSY.	MAIN FEED DOG	AUX. FEED DOG	DIFF. FEED DOG	PRESSER FOOT ASSY.	PRESSER FOOT FINGER	UPPER LOOPER	LOWER LOOPER								
M852-01	4	4	2025731	2080930-BF0	(20479A,BF0)	(2046740)	2047300	201152E0	201156C0 #34	2040620 #2	2040720	201121A0						
M852-13	2	4	20254E1	208078-BF0	(20467A,BF0)	(2046740)	204676-BF0	2087300	2087300	2087321 #38	2049631 #91	2040720	201121A0					
M852-16S2	2	5	202499E1	208078-BF0	(20467A,BF0)	(2046740)	204676-BF0	2087300	2087300	2087321 #38	2049631 #91	2040720	201121A0					
M852-17	1.5	4	202546E1	208078-BF0	(20467A,BF0)	(2046740)	204676-BF0	201230C0	2055250 #57	2103710 #2	2040620 #2	2040720	201121A0					
M852-17	4	4	202546E1	208078-BF0	(20467A,BF0)	(2046740)	204676-BF0	201230C0	209417A25F0	208050A0 #91	2082091 #13	2049810	201121A0					
M852-23B	2.5	4.5	209508-451	209509-25F0	(209416-25F0)	(2046740)	204676-BF0	2772960	3F000102500	2772960	3T000300000	2F000200000 #16	2040720	2040720	2040720	2770000		
M852-90	---	6	2P000106001	---	---	(2046740)	204730A16F0	2772960	3F000102500	2772960	3T000300000	2F000200000 #16	2040720	2040720	2040720	2770000		
M852-180	---	4	202618A1	208090A16F0	(204729B16F0)	(2046740)	204730A16F0	2772960	3F000102500	2772960	3T000300000	2F000200000 #16	2040720	2040720	2040720	2770000		
M852-181	2	4	2097321	209740-16F0	(209741-16F0)	(2046770)	209742-16F0	2052530	2097340 #66	2097340 #66	2049831 #91	2040720	201121A0					

M852 GAUGE PARTS LIST

マシン形式 MACHINE TYPE /SPEC.	ゲージ GAUGE	下メス LOWER KNIFE	針受け		針留		針
			前	後	前	後	
M852-01	4	4	2022950	2046591	2080090	179630-920	DC×27 #9
M852-13	2	4	2022950	2046591	2080090	277022-920	DC×27 #9
M852-16S2	2	5	2022950	2046591	2080090	277022-920	DC×27 #9
M852-17	1.5	4	2022950	2046591	2080090	179630-920	DC×27 #11
M852-17	---	4	2022950	2046591	2080090	179630-920	DC×27 #9
M852-23B	2.5	4.5	2022950	2046591	2080090	277023-920	DC×27 #14
M852-90	---	6	2770091	2046591	2080090	277086-920	DC×27 #14
M852-180	---	4	2022950	2046591	2080090	179630-920	DC×27 #9
M852-181	2	4	2022950	2046591	2080090	277022-920	DC×27 #9

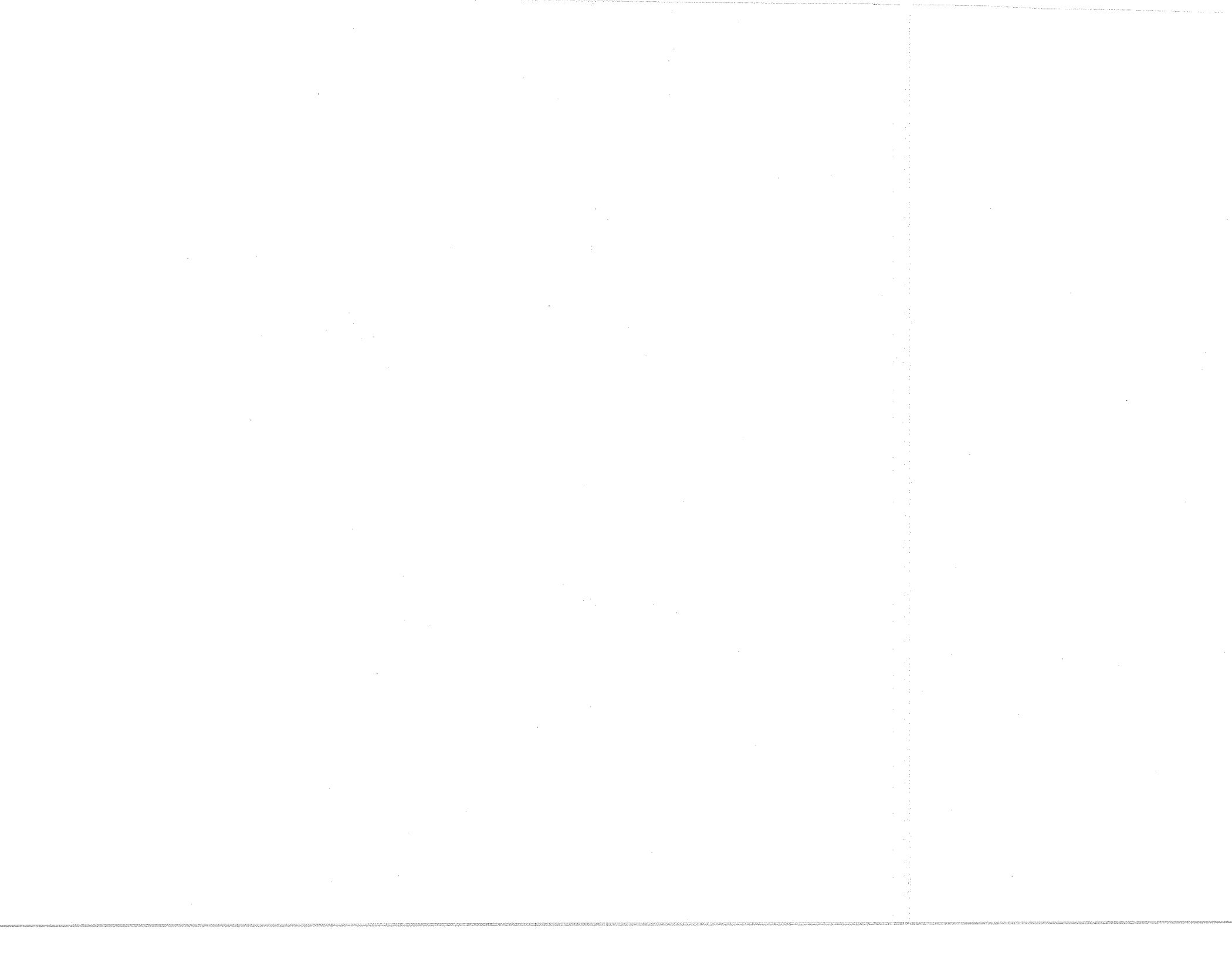

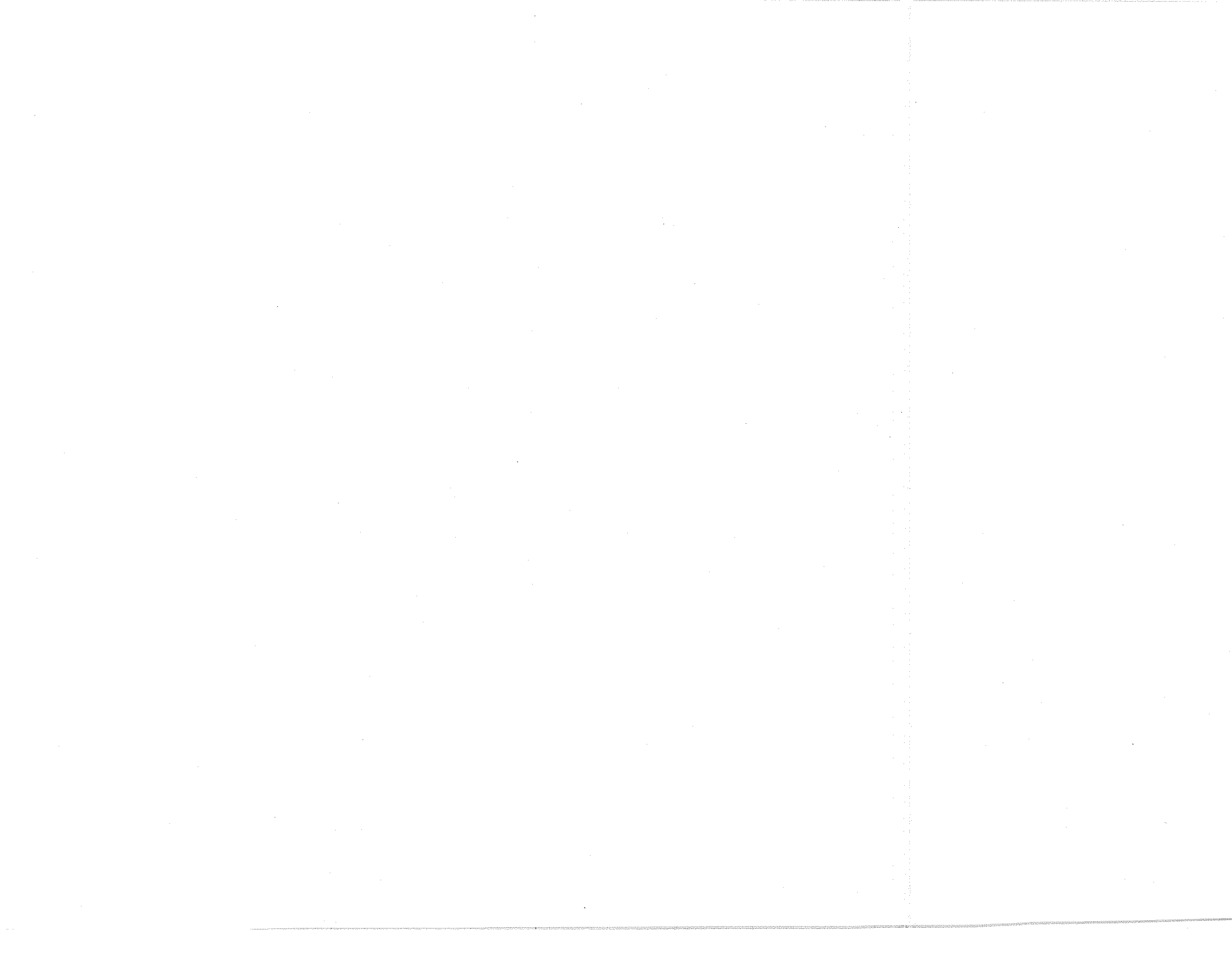

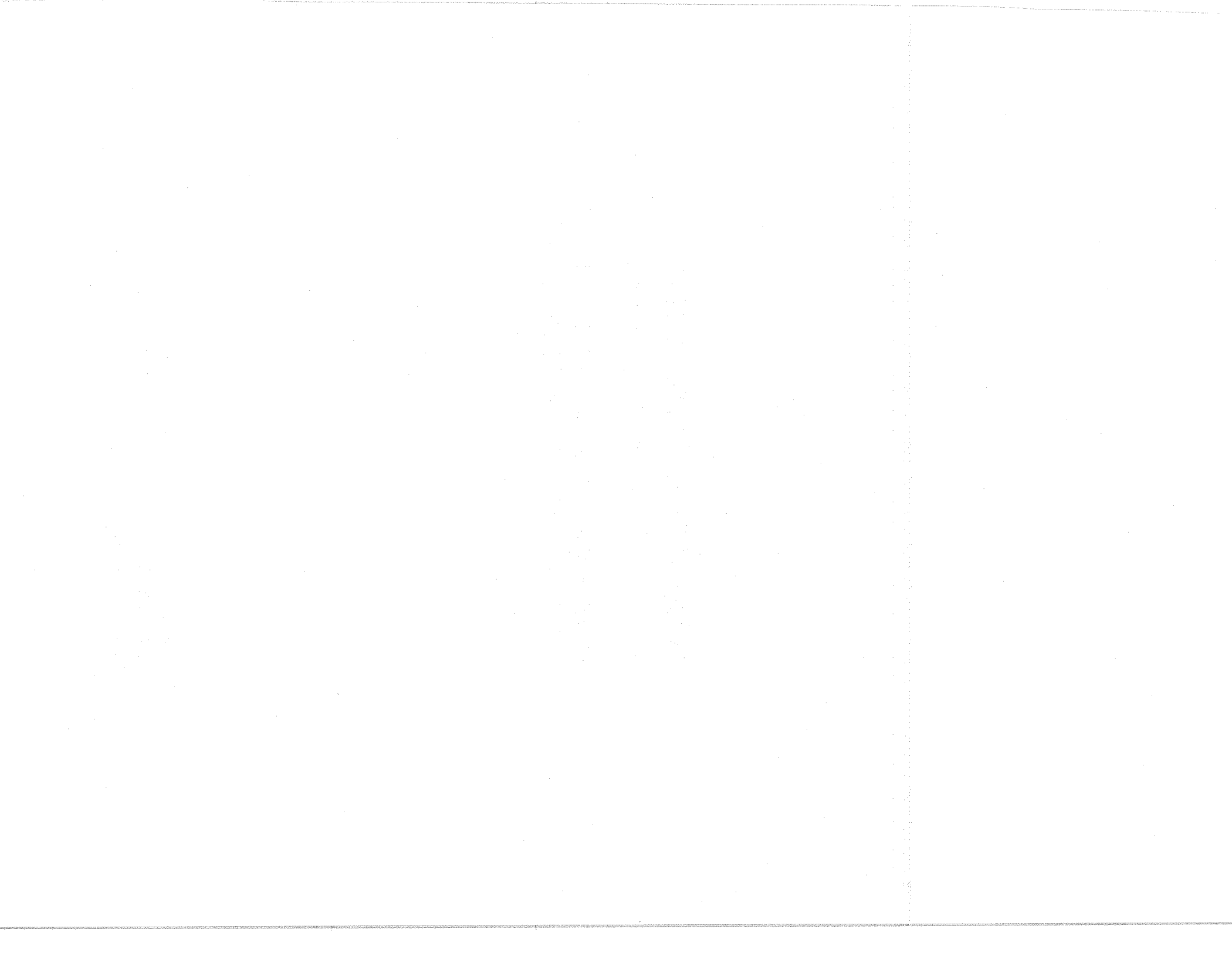

ペガサスミシン製造株式会社

本社 〒 553-0002 大阪市福島区鷺洲 5-7-2 TEL (06) 6458-4739
FAX (06) 6454-8785

PEGASUS SEWING MACHINE MFG. CO., LTD.

5-7-2, Saigisu, Fukushima-ku, Osaka 553-0002, Japan. Phone : (06) 6458-4739
Telefax: (06) 6454-8785

Cat. No. 9B100200001 December 2005
©2005 PEGASUS SEWING MACHINE MFG. CO., LTD.

このパーツチェッカーに記載されている内容は、改良のため予告なく変更することがあります。

The description in this PARTS CHECKER is subject to change without prior notice for improvement.